

Recommendations for the Installation of the Profab Access **INTEGRA 4000 Series** Fire Rated Riser Door with the **PRECISION Adjustable Frame**

certifire



MADE IN BRITAIN

» CONTACT US

Profab Access, Riversdale House, Units C-D Riversdale Road,
Carlyon Road Industrial Estate, Atherstone, Warwickshire CV9 1FA, UK

Sales Enquiries: +44(0) 1827 718 222 sales@profabaccess.com

Technical Enquiries: +44(0) 1827 719 051 technical@profabaccess.com





www.profabaccess.com

Profab Access is part of the Access 360 division of Tyman UK & Ireland.

SAFE ACCESS ALL AREAS



» CONTENTS

Handling, storage & protection	P3
Handling	P3
Storage	P3
Protection	P3
Before You Start	P4
Opening	P4
Door Finishes	 P4
Installation	P4
Clearances	P4
Adjusting Panel Sizes	P4
Apertures	P4
Frame Installation	P5
Fixings	P5
Tools & Components Required	P5
Beaded Frame (ABF) with Metal Door (MD)	 P6
Picture Frame (APF) with Metal Door (MD)	 P8
Spar For Multiple Doors	P9
Plastering a Beaded Frame (BF)	P9
Intumescent Mastic & Smoke and Acoustic Seals	P10
Locking Options	P10
Locking Operation	 P10
3 Point Lock	P10
3 Point High Security Lock	P11
3 Point High Security Concealed Lock	P11
Keys	P12
Safety Handrails	 P12



» CONTACT US

Profab Access, Riversdale House, Units C-D Riversdale Road,
Carlyon Road Industrial Estate, Atherstone, Warwickshire CV9 1FA, UK

Sales Enquiries: +44(0) 1827 718 222 sales@profabaccess.com

Technical Enquiries: +44(0) 1827 719 051 technical@profabaccess.com

www.profabaccess.com

Profab Access is part of the Access 360 division of Tyman UK & Ireland.

SAFE ACCESS ALL AREAS



» HANDLING STORAGE & PROTECTION

Handling

- Profab Access's riser doors and doorsets are high quality products and therefore require an appropriate level of protection on site. We recommend the packaging should not be removed until immediately before the doorsets are ready to be installed.
- Our products can be heavy so please take extra care to avoid damage to the product and prevent injury to site personnel. Always work in accordance with each site's manual handling policy.
- Our products are designed for forklift truck off-loading and will be supplied wrapped in stacks for ease of distribution.

Storage

The correct storage conditions for Profab Access's products is essential to ensure the product performs and appears as specified. Storage and protection of the products on site is the responsibility of the contractor. Profab Access's products should be stored close to the final installation area or in a location with limited access and traffic.

DO NOT

- **Store on panel/frame edge.**
- **Store directly on the floor.**
- **Store near heaters.**
- **Stack product lent against walls.**
- **Stock product over 1 metre high.**
- **Store other product on top of the stored panels.**
- **Restack panels after delivery without using the same material or method to that used while the products were being transported.**

Protection

All panels are supplied with installed Protek protection and is applied to allow the door to function after installation (not applicable to Plaster Board panels or tiled panels). The product is then wrapped in shrink wrap to protect the product during transportation. It is essential to protect the panels after they are installed until the handover of the building. Protek will protect the door facings and will give basic protection from paint and dirt etc, the Protek will not protect the doors from impacts and it is the responsibility of the contractor's to assess the level of protection required for the panel and provide it. When reapplying the Protek or applying other types of protection a low tack adhesive tape should be used, do not use any form of packing tape or duck types of tape as this may damage the powder coating finish and mark the doorset's.

Additional low tack tape can be purchased, please contact a member of the Profab team.

It is recommended that a box knife is used to remove the transport protection as an open blade may scratch/damage the product.

» CONTACT US

Profab Access, Riversdale House, Units C-D Riversdale Road,
Carlyon Road Industrial Estate, Atherstone, Warwickshire CV9 1FA, UK

Sales Enquiries: +44(0) 1827 718 222 sales@profabaccess.com

Technical Enquiries: +44(0) 1827 719 051 technical@profabaccess.com

www.profabaccess.com

SAFE ACCESS ALL AREAS



» BEFORE YOU START

Opening

- Make sure that you have the correct panel/doorset in relation to the opening in which it is going to be installed; each product has a unique reference located on the label (Door Number), which links with the contract drawings and schedules.
- Check the structural opening is plumb and level before you start installation. Our product is designed to allow for an opening to be no greater than 5mm out of square.
- Before removing the packaging check that the overall dimensions of the panel will fit the opening it is intended for, if correct remove the transport packaging and take care to retain any loose items.

» DOOR FINISHES

All steel components of the panel and frame are supplied with a powder coat finish (white). This finish can be the finished item with no additional finish required or can be painted over to match other wall finishes.

When painting the panels the powder coat will require a light sand/de-nibbing, this will key the paint to the powder coat.

If in doubt or if there are any questions, please contact a member of the Profab Access technical team on 01827 719 051 or email technical@profabaccess.com

» INSTALLATION

Clearances

The following clearances should be achieved around the panel when closed to comply with fire certification and for the product to function correctly.

- Frame to door gap = 4mm maximum (Manufactured to allow 3mm)
- Meeting Stiles gap = 4mm maximum (Manufactured to allow 3mm)
- Structural opening to frame gap = 7.5mm allowance

Adjusting panel sizes

All of our panels are made to measure and cannot be cut down or adjusted. It is recommended that the structural openings are measured prior to the panels being manufactured.

Apertures

No site cutting of any type of aperture is permitted.

» CONTACT US

Profab Access, Riversdale House, Units C-D Riversdale Road,
Carlyon Road Industrial Estate, Atherstone, Warwickshire CV9 1FA, UK

Sales Enquiries: +44(0) 1827 718 222 sales@profabaccess.com

Technical Enquiries: +44(0) 1827 719 051 technical@profabaccess.com

www.profabaccess.com

» FRAME INSTALLATION

- Frame packers are NOT required when installing the PRECISION Adjustable Frame
- The product's unique construction enables the frame to be fully self-adjusting to the specific dimensions of each structural opening ensuring the highest standards in accuracy and providing contractors with a safer, faster and simpler installation process.
- Intumescent mastic application is NOT required when installing the PRECISION Adjustable Frame
- The adjustable frame has factory applied intumescent strips eliminating the need for additional intumescent mastic application

» FIXINGS

- For masonry or concrete: Profab Access's doorsets must be installed using a minimum M6 steel anchor fixings.
- For plasterboard wall assemblies: Profab Access's doorsets must be installed using a minimum No 6 plasterboard screws (steel) or steel woodscrews.

» TOOLS & COMPONENTS REQUIRED

- Battery or mains drill or screw driver, suitable for masonry walls if applicable.
- 10mm socket & wrench or 10mm sock and attachment for a battery driver.
- Basic hand tools.
- Various length spirit level dependent on the panel size, it is advised that a suitable length spirit level is used for the panel which is being installed. e.g. it is not recommended to use a 300mm level on a 1800mm long frame section.

» CONTACT US

Profab Access, Riversdale House, Units C-D Riversdale Road,
Carlyon Road Industrial Estate, Atherstone, Warwickshire CV9 1FA, UK

Sales Enquiries: +44(0) 1827 718 222 sales@profabaccess.com

Technical Enquiries: +44(0) 1827 719 051 technical@profabaccess.com

www.profabaccess.com

Profab Access is part of the Access 360 division of Tyman UK & Ireland.

SAFE ACCESS ALL AREAS



» **ADJUSTABLE BEADED FRAME (ABF) WITH METAL DOOR (MD)** 

To fit the adjustable frame

- Ensure the opening in the structural wall is level and plumb and the opening is around 15mm larger than the frame.
- Loosen all the fixings on the rear of the frame and place it into the wall aperture
- Insert the jacking screws top and bottom if they are not already fitted into the frame



Adjust the position of the frame using the jacking screws to ensure it is aligned vertically and horizontally within the structural opening.



Face fix the beaded frame to the wall using suitable substrate screws. Ensure the fixings do not protrude past the face of the bead.



Secure the self-adjusting frame to the stud work through the side fixings using suitable substrate screws.

- **Plastic packers are NOT required when fitting the frame**
- **Intumescent mastic application is NOT required when fitting the frame**



Ensure the foam gasket has been compressed by the frame channel to ensure a good seal with the substructure.



Secure the frame on all sides through all fixing points of the frame.



Lock the real bolts on the back of the frame ensuring the plates are pushed tight against the sub frame.

- Remove all of the jacking screws from the frame

» **CONTACT US**

Profab Access, Riversdale House, Units C-D Riversdale Road,
Carlyon Road Industrial Estate, Atherstone, Warwickshire CV9 1FA, UK

Sales Enquiries: +44(0) 1827 718 222 sales@profabaccess.com

Technical Enquiries: +44(0) 1827 719 051 technical@profabaccess.com

www.profabaccess.com

Profab Access is part of the Access 360 division of Tyman UK & Ireland.

SAFE ACCESS ALL AREAS



» **ADJUSTABLE BEADED FRAME (ABF) WITH METAL DOOR (MD)**  (Continued)

To fit the riser door



Position the spacer along the hinged side of the frame and door assembly.



Add shims to allow gap adjustment if required.



Fit the INTEGRA 4000 Series door leaf by locating the frame hinge pins into the continuous piano hinge.

- Apply the fixing nuts to fix the door to the frame
- Before inserting the remaining fixings ensure the locking device can be located into the frame and lock
- Ensure all gaps between the door and the frame are equal
- Insert the remaining fixings to secure the door, ensure all fixing holes are used.

» **CONTACT US**

Profab Access, Riversdale House, Units C-D Riversdale Road,
Carlyon Road Industrial Estate, Atherstone, Warwickshire CV9 1FA, UK

Sales Enquiries: +44(0) 1827 718 222 sales@profabaccess.com

Technical Enquiries: +44(0) 1827 719 051 technical@profabaccess.com

www.profabaccess.com

Profab Access is part of the Access 360 division of Tyman UK & Ireland.

SAFE ACCESS ALL AREAS



» **ADJUSTABLE PICTURE FRAME (APF) WITH METAL DOOR (MD)** 

To fit the adjustable frame

- Ensure the opening in the structural wall is level and plumb and the opening is around 15mm larger than the frame.
- Loosen all the fixings on the rear of the frame and place it into the wall aperture



Insert the jacking screws top and bottom if they are not already fitted into the frame.



Adjust the position of the frame using the jacking screws to ensure it is aligned vertically and horizontally within the structural opening.



Factory applied intumescent strips eliminate the need for intumescent mastic application.

- Secure the self-adjusting frame to the stud work through the side fixings using suitable substrate screws
- **Plastic packers are NOT required when fitting the frame**
- **Intumescent mastic application is NOT required when fitting the frame**
- Ensure the foam gasket has been compressed by the frame channel to ensure a good seal with the substructure
- Secure the frame on all sides through all fixing points of the frame
- Lock the real bolts on the back of the frame ensuring the plates are pushed tight against the sub frame
- Remove all of the jacking screws from the frame

To fit the riser door

- Position the spacer along the hinged side of the frame and door assembly
- Add shims to allow gap adjustment if required
- Fit the INTEGRA 4000 Series door leaf by locating the frame hinge pins into the continuous piano hinge
- Apply the fixing nuts to fix the door to the frame
- Before inserting the remaining fixings ensure the locking device can be located into the frame and lock
- Ensure all gaps between the door and the frame are equal
- Insert the remaining fixings to secure the door, ensure all fixing holes are used.

» **CONTACT US**

Profab Access, Riversdale House, Units C-D Riversdale Road,
Carlyon Road Industrial Estate, Atherstone, Warwickshire CV9 1FA, UK

Sales Enquiries: +44(0) 1827 718 222 sales@profabaccess.com

Technical Enquiries: +44(0) 1827 719 051 technical@profabaccess.com

www.profabaccess.com

Profab Access is part of the Access 360 division of Tyman UK & Ireland.

SAFE ACCESS ALL AREAS



» SPAR FOR MULTIPLE DOORS

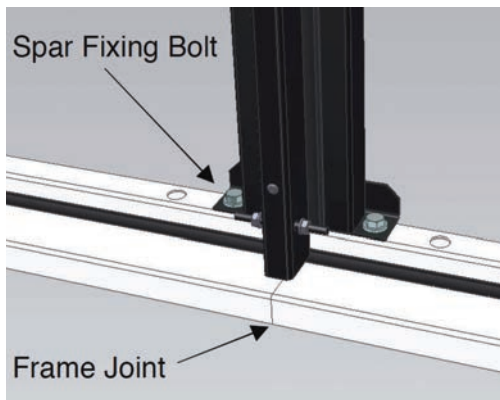

Some 4000 series panels are required to have multiple leafs, these doors and frame will be delivered with a black spar. In some cases this spar is used to connect multiple frames together.

- Before installing the frame into the opening lay the frames flat on the ground.
- Position the frames together and position the spar into place.
- Using the bolts provided bolt the spar to the frames.
- Install the frame as normal.

Due to the large size of some frames it may require multiple operatives to lift the frame into the opening, the frame may also be assembled in the opening if space is limited.

» PLASTERING A BEADED FRAME

- Spread finish coat plaster (skimming) or jointing compound (tape & Jointing) along the bead overlapping onto the plasterboard surface. 'Bed in' paper joint tape by pressing it firmly into the plaster/ jointing compound material.

Note, Paper tape is preferred to self-adhesive fibre tape as it generally considered to give better resistance to cracking.

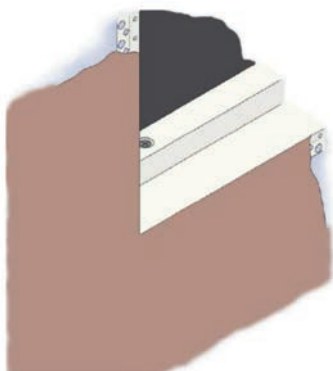
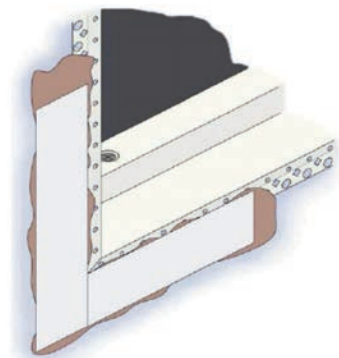

- Plaster skimming – Trowel apply finish coat plaster ensuring the paper tape remains positioned and that the plaster is pushed through the tape well into any gaps between the beaded frame and the plasterboard surface. Finish the skimming with a firm pressure to the beaded frame joint after the joint treatment has stiffened but not set.
- Taping and jointing – Trowel apply 2 or 3 applications of jointing compound allowing each to set dry before the next application, feathering each out beyond the previous application. Sand as required to achieve a smooth surface.

- Remove any excess plaster that may have fallen between the frame and panel.
- If plastering the frame while the panel is installed ensure the gap between the frame and panel is free from plaster or jointing compound. Plaster/jointing compound within the gap may result in the panel being damaged during operation.

» CONTACT US

Profab Access, Riversdale House, Units C-D Riversdale Road,
Carlyon Road Industrial Estate, Atherstone, Warwickshire CV9 1FA, UK

Sales Enquiries: +44(0) 1827 718 222 sales@profabaccess.com

Technical Enquiries: +44(0) 1827 719 051 technical@profabaccess.com

www.profabaccess.com

Profab Access is part of the Access 360 division of Tyman UK & Ireland.

SAFE ACCESS ALL AREAS



» INTUMESCENT MASTIC & SMOKE AND ACOUSTIC SEALS

- The adjustable frame is bi-directionally fire tested with the INTEGRA 4000 Series fire rated door to BS EN 1634:2014 + A1:2018 and CERTIFIRE accredited up to 120 minutes.
- The product’s unique construction enables the frame to be fully self-adjusting to the specific dimensions of each structural opening.

Packers are NOT required when installing the adjustable frame.

- The frame is supplied with factory applied intumescent strips, and constructed with an all-in-one smoke, intumescent and acoustic FS 1000 seal

Intumescent mastic application is NOT required when installing the adjustable frame.

» LOCKING OPTIONS

There are a 3 different locking options, all locks are installed and set during the manufacturing process with no need for adjustment once on site.



3 Point lock (3PL)
T-Bar key



3 Point High Security Lock (3HS)
Euro profile lock and T-Bar key

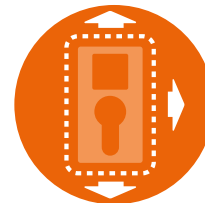

Concealed Lock (3HSCE)
3 Point High Security Lock
with magnetic escutcheon

» LOCK OPERATION

3 Point Lock

This lock is a simple T-Bar key lock. To operate insert a T-Bar key into the face of the panel and turn clockwise or anti-clock wise to lock/unlock the panel.



Hole within panel



Insert key



Key inserted and turn to open

The cover/collar is either a simple hole, stainless steel collar or plastic collar and bung that makes good the hole cut in the door.

» CONTACT US

Profab Access, Riversdale House, Units C-D Riversdale Road,
Carlyon Road Industrial Estate, Atherstone, Warwickshire CV9 1FA, UK

Sales Enquiries: +44(0) 1827 718 222 sales@profabaccess.com

Technical Enquiries: +44(0) 1827 719 051 technical@profabaccess.com

www.profabaccess.com

Profab Access is part of the Access 360 division of Tyman UK & Ireland.

SAFE ACCESS ALL AREAS



3 Point High Security Lock

This lock type has both a cylinder and T-Bar key opener.

Both are required to operate the lock/door.

- Insert the key and square T-Bar key into the lock
- Turn the cylinder key and hold the key in the open position, this will then unlock the ability to use the T-Bar key.
- Turn the T-Bar key and the door will unlock the T-Bar can be used to pull the door open.

If the square key does not operate, the cylinder key is not turned fully, turn the cylinder key within the lock and rotate the T-Bar key.



Hole within panel

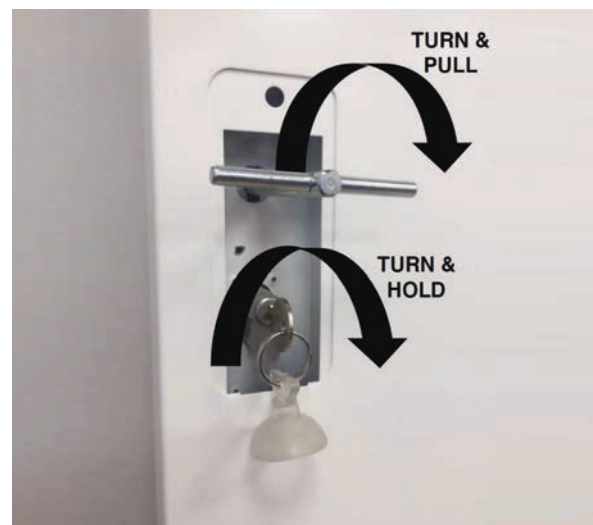

Insert key

3 Point High Security Concealed Lock

Lock cover, this is a rectangular cover which has a locating tap at the bottom and a small magnet at the top, using a suction cup pull the top of the cover and remove.



Cover installed flush



Cover being pulled



Cover removed

CONTACT US

Profab Access, Riversdale House, Units C-D Riversdale Road,
Carlyon Road Industrial Estate, Atherstone, Warwickshire CV9 1FA, UK

Sales Enquiries: +44(0) 1827 718 222 sales@profabaccess.com

Technical Enquiries: +44(0) 1827 719 051 technical@profabaccess.com

www.profabaccess.com

Profab Access is part of the Access 360 division of Tyman UK & Ireland.

SAFE ACCESS ALL AREAS



» **HANDLING STORAGE & PROTECTION**

Keys

Any special keys or euro profile keys are supplied with the product, these may be dependent on your lock option the T-Bar key, suction cup and or euro profile cylinder key. Please be careful when unpacking the panels that these loose items are not discarded.

Additional items can be purchase, please contact a member of the Profab team.

Note, unless specified the euro profile cylinder keys are not suited and are construction issue, it is assumed these will be replaced by other into a suited key system.



» **SAFETY HANDRAILS – OPTIONAL** 

Safety Rails are an optional extra that can be fitted to eliminate the risk of falling if there are voids within the riser cavity.

Each hand rail is secured with 4 fixing bolts for strength.

Quantity and location is dependent on the client requirements.



» **CONTACT US**

Profab Access, Riversdale House, Units C-D Riversdale Road, Carlyon Road Industrial Estate, Atherstone, Warwickshire CV9 1FA, UK

Sales Enquiries: +44(0) 1827 718 222 sales@profabaccess.com

Technical Enquiries: +44(0) 1827 719 051 technical@profabaccess.com

www.profabaccess.com

SAFE ACCESS ALL AREAS

